

OCULUS ImageCam® 3

Slit Lamp Documentation

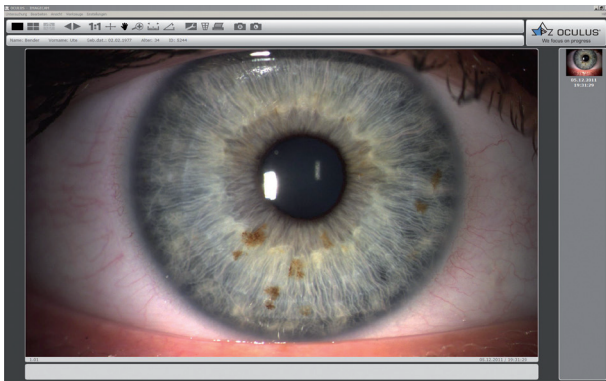

Perfectly presented results



Single-image mode – iris naevi

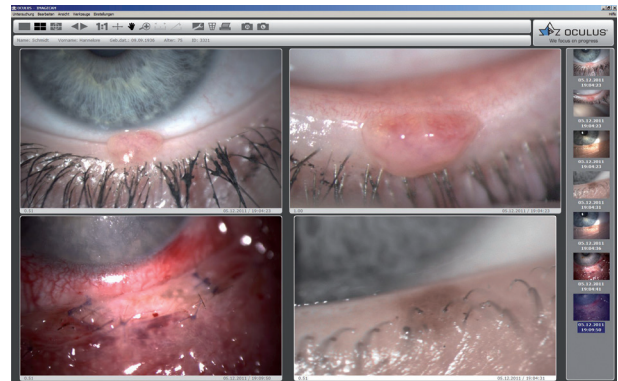

Four-image mode – eyelid surgery follow-up



Single-image mode – fluorescein imaging

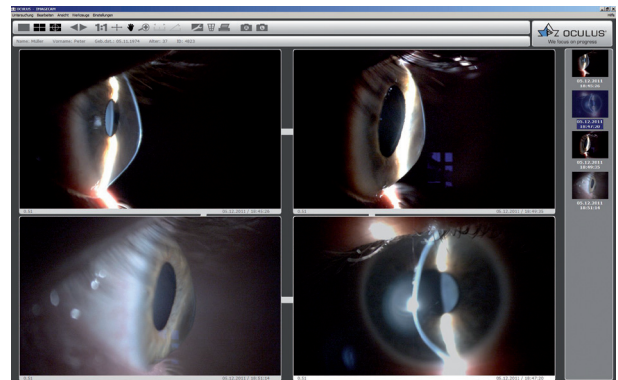

Four-image mode – corneal degeneration

Combine the ImageCam® 3 with your OCULUS Keratograph

The ImageCam® 3 software can be linked to the software of your OCULUS Keratograph, enabling you to compare fluo images simulated on the Keratograph with real fluo images taken with a slit lamp.

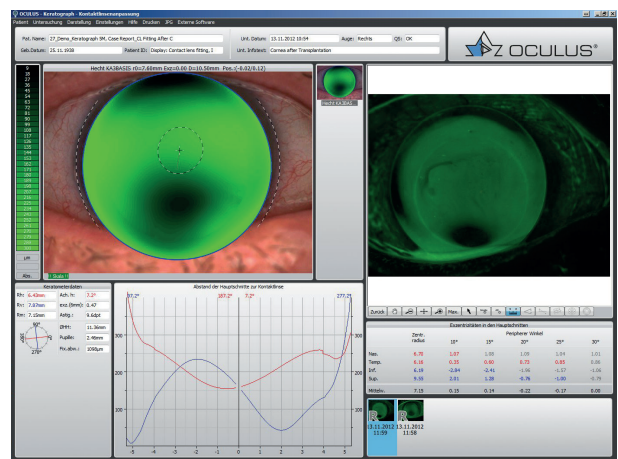

Keratograph and ImageCam® 3 software linked together

OCULUS ImageCam® 3

High-performance image documentation system

Versatile application

Document the results of your slit lamp examinations with telling images or video sequences. The ImageCam® 3 will support you in doing so with its versatile functions. Serial imaging and exposure bracketing ensure perfect images, and the video function allows you to film your entire slit lamp examination.

Application examples

- Documentation of the anterior and posterior eye segment
- Images for patient consultation
- Fluor image assessment for contact lens fitting
- Follow-ups and comparisons
- Storage and archiving of findings

The hardware

- Super light sensitive USB 3.0 camera
- High-definition optics optimized for the camera
- Ultra-compact beam splitter
- Optics can be swivelled in and out
 - out: no optical impediment when looking through slit lamp
 - in: abundant light for image documentation
- Additional mechanical iris aperture for adjusting depth of focus and exposure control directly at the beam splitter
- Adaptable to virtually any slit lamp

The software

- Patient data management
- Image viewer
 - Single images or video sequences
 - Single-image mode (detailed representation) and four-image mode (e.g. for follow-up)
 - Image from video
 - Magnifying function
 - Measurement of lengths and angles
 - Comment field for recording abnormalities
 - Image correction for colour, brightness, contrast etc.
 - Printing function for selected images
- Camera window
 - Pre-defined exposure programs with quick-access icons
 - Individual exposure programs can be defined
 - Easy image capture by mouse click or footswitch, or, in the „digital ready“ versions of OCULUS slit lamps, using the joystick
 - Live image viewing on monitor



*OCULUS ImageCam® 3
mounted on the OCULUS SL-IC4 D*

Perfect Images

Serial imaging and exposure bracketing for excellent results

Serial imaging for capturing the right moment

Its quick movements make the eye a challenging photo subject. Typical image artefacts include motion blur and image shake. The serial imaging function of the ImageCam® 3 helps you to avoid such artefacts by taking images of the eye when it is at rest.

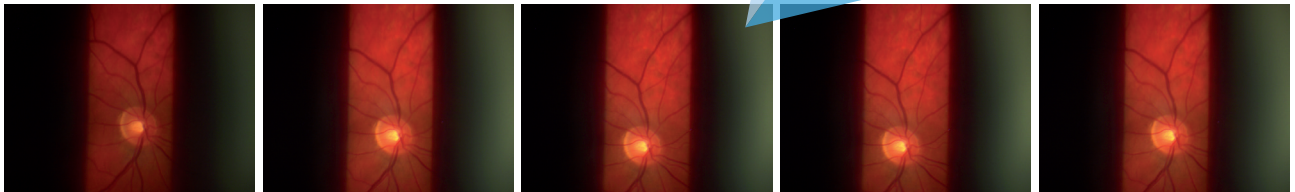
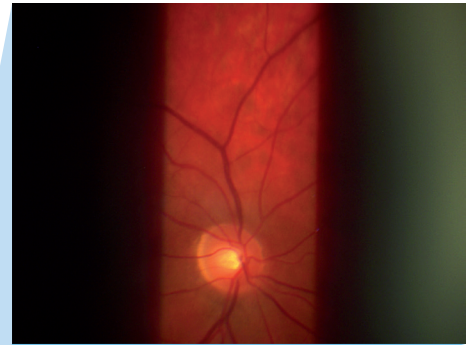

Serial capture mode

Exposure bracketing with incremental exposure time

The eye's ability to adapt to light and dark makes it difficult for the examiner to correctly predict the exposure of slit lamp images. The ImageCam® 3 varies the exposure time for you automatically. From five images you can choose the one with the best exposure.

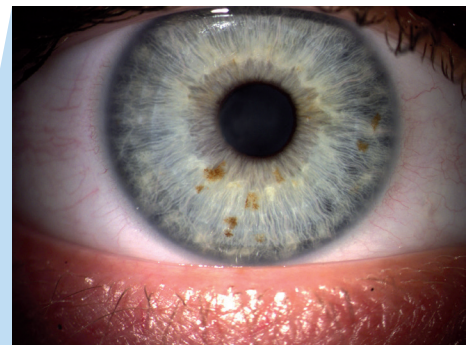

Serial images with incremental exposure time

Everything on Film

Document your entire examination and create single images later on as well

Video recordings – Be the examiner and film director in one

Film your slit lamp examinations and extract the best images for your documentation. The ImageCam® 3 saves videos consisting of highest-definition images. Selecting the most suitable image only takes you seconds. You can then use the mouse wheel to whizz from one image to the next and store the desired one in your image library with one mouse click.

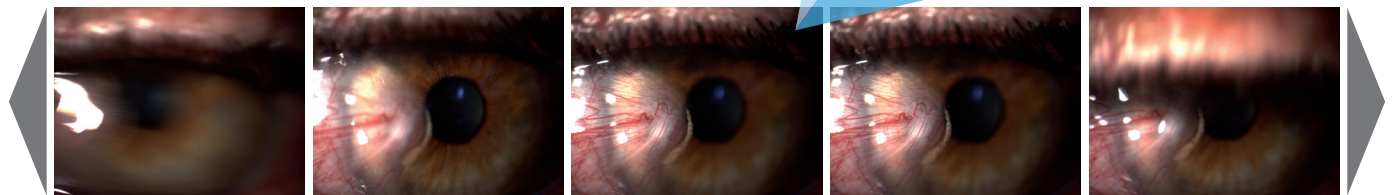
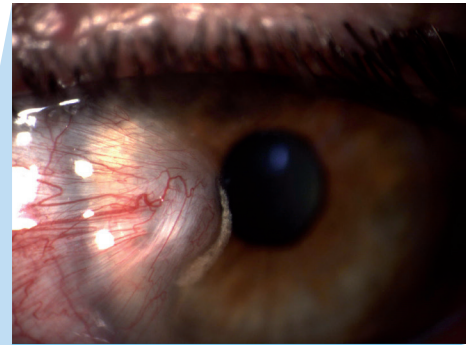

Picture from video

Simply practical – the footswitch for the ImageCam® 3

The ImageCam® 3 is equipped with a footswitch to make your job easier. On the OCULUS slit lamps SL-IC4 D or SL-IC5 D you can also simply use the joystick for image capture. To take an image or start a video or exposure series just press the footswitch or joystick button. Prolonged activation of the footswitch/joystick button allows you to switch between single-image and video recording mode.

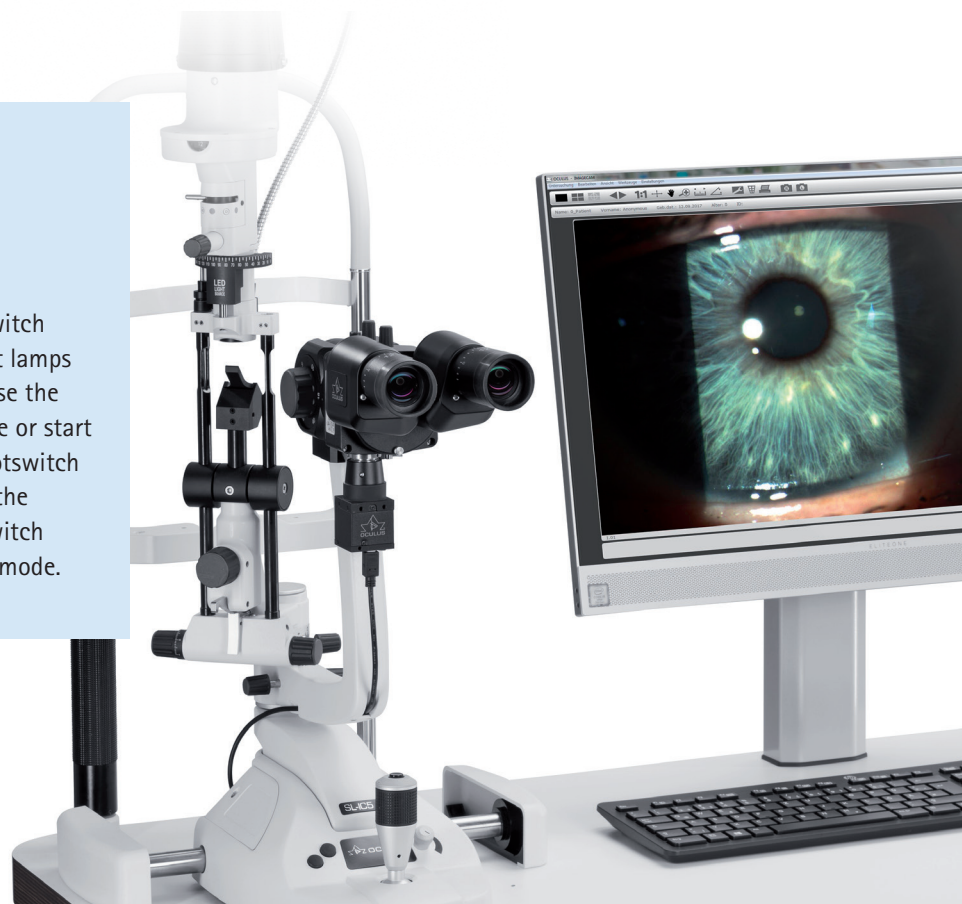

Technical Data

OCULUS ImageCam® 3

Camera	
Camera	Progressive scan
Interface	USB 3.0
Shutter system	Global shutter
Beam splitter	
Splitting ratio	70/30 (camera/binocular)
Splitting cube	swing-in/swing-out
Aperture (mechanical)	adjustable
Software	
Image viewer	Image processing, measuring tool, printing and export, camera control
Image format	JPG, BMP
Video format	AVI, MJPEG
Network capability	Central data base with viewer software
Technical specifications	
Dimensions camera (W x D x H)	29 x 29 x 48 mm (1.1 x 1.1 x 1.9 in)
Dimensions beam splitter (W x D x H)	92 x 39 to 55 x 93 mm (3.6 x 1.5 to 2.2 x 3.6 in), depending on model
Weight camera	47 g (1.7 oz)
Weight beam splitter	335 to 480 g (11.8 to 16.9 oz), depending on model
Recommended computer requirements	Intel Core™ i5, 256 GB SSD, 1 TB SATA, 8 GB RAM, Windows® 10 Pro, USB 3.0
Recommended screen resolution	1 920 x 1 200 pixel

CE in accordance with Medical Device Directive 93/42/EEC

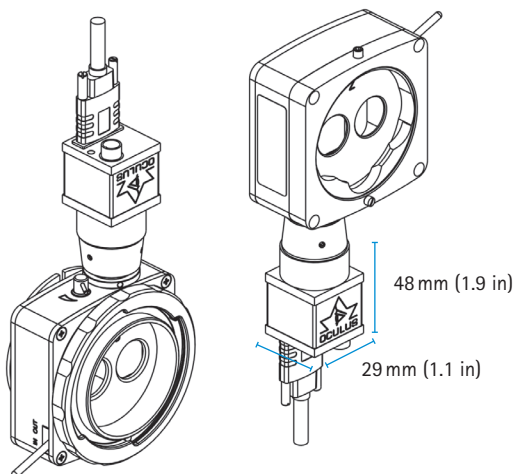

Adapting options

Adaptable to virtually any slit lamp: Whether the OCULUS ImageCam® 3 is mounted with the camera downwards or upwards is depending on the respective slit lamp model.

Examples: with adapter for a Haag-Streit slit lamp (left), with adapter for a ZEISS slit lamp (right)

WWW.OCULUS.DE

OCULUS Optikgeräte GmbH
Postfach • 35549 Wetzlar • GERMANY
Tel. +49 641 2005-0 • Fax +49 641 2005-295
Email: export@oculus.de • www.oculus.de

- OCULUS Asia, info@oculus.hk
- OCULUS Brasil, info@oculusbrasil.com.br
- OCULUS Canada, sales@oculus.ca
- OCULUS Czechia, oculus@oculus.cz
- OCULUS Iberia, info@oculus.es
- OCULUS Turkey, info@oculus-turkey.com.tr
- OCULUS USA, sales@oculususa.com



OCULUS is certified by TÜV according to DIN EN ISO 13485 MDSAP